

Product family

SPOTY ROUND 5

Recessed spotlight made of aluminum, available in different housing colors, with recessed LED insert, rigid, can be equipped with various LED inserts, also with new LED technology WARMDIM and TUNABLE WHITE, standard with 30° lens (other version on request), CRI > 95Ra (except Tuneable White insert CRI90Ra), incl. external converter (dimmable phase angle or phase section), optional DALI / SwitchDim



CHARACTERISTIC

- made of aluminium
- rigid
- 4 housing colors to choose from
- with recessed LED insert
- 5 LED inserts to choose from
- for ceiling cut-out Ø 77mm
- degree of protection: IP20
- external converter (dimmable phase angle or phase section) optional DALI / SwitchDim

ADVANTAGES

- with new LED technology WARMDIM and TUNABLE WHITE



Product overview:

Housing colors:



black



gold



brushed alu

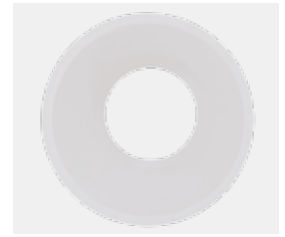

white

LED-inserts:



LED insert 7W



LED insert 13W



LED insert 7W Warmdim



LED insert 13W Warmdim



LED insert Tunable White

Light color:



2700K super warm white



3000K warm white

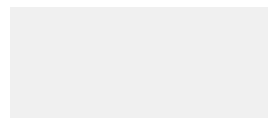

4000K neutral white



1800K - 3000K WarmDim



2700K - 6000K

Control:

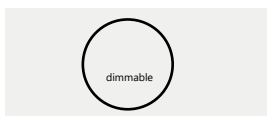

phase angle or phase section dimmable



DALI dimmable (on request)

Drawings:

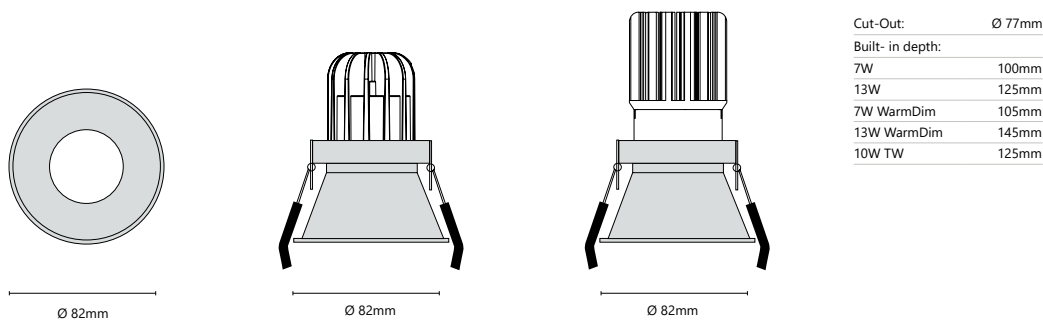

Technical informationen:

7W INSERT

Total watt:	7W		
Net lumen:	492lm	492lm	614lm
Kelvin (CCT):	2700K	3000K	4000K
Protection:	IP20		
CRI:	>95Ra		
Beam angle:	30°		
Life expectancy:	50.000h		
Voltage:	100 ~ 230V AC/ 700mA DC		

13W INSERT

Total watt:	13W		
Net lumen:	1010lm	1109lm	1333lm
Kelvin (CCT):	2700K	3000K	4000K
Protection:	IP20		
CRI:	>95Ra		
Beam angle:	30°		
Life expectancy:	50.000h		
Voltage:	100 ~ 230V AC/ 350mA DC		

7W WARM DIM INSERT

Watt Total:	7W		
Nettolumen:	570lm		
Kelvin (CCT):	1800K - 3000K		
Protection:	IP20		
CRI:	>95Ra		
Winkel:	30°		
Lebenserwartung:	50.000h		
Spannung:	100 ~ 230V AC/ 350mA DC		

13W WARM DIM INSERT

Watt Total:	13W		
Nettolumen:	1150lm		
Kelvin (CCT):	1800K - 3000K		
Protection:	IP20		
CRI:	>95Ra		
Winkel:	30°		
Lebenserwartung:	50.000h		
Spannung:	100 ~ 230V AC/ 350mA DC		

10W INSERT

Watt Total:	10W		
Nettolumen:	900~930lm		
Kelvin (CCT):	2700K - 5700K		
Protection:	IP20		
CRI:	>90Ra		
Winkel:	30°		
Lebenserwartung:	50.000h		
Spannung:	100 ~ 230V AC/ 350mA DC		

Article overview:

item number	① watt	② kelvin	③ lens	④ color	control
LW25-R5-①-②-③-④	» 07 « 7W	» 2700 « » 3000 « » 4000 «	» 1 « 30° (Standard)	» B « black	dimmable phase angle or phase section (Standard) DALI/SwitchDim (on request)
	» 13 « 13W	» 2200 « (warmdim)		» G « gold	
	» 10 « 10W	» TW « (2700-5700K)		» S « brushed alu	
				» W « white	

1800K



3000K



2700K



5700K

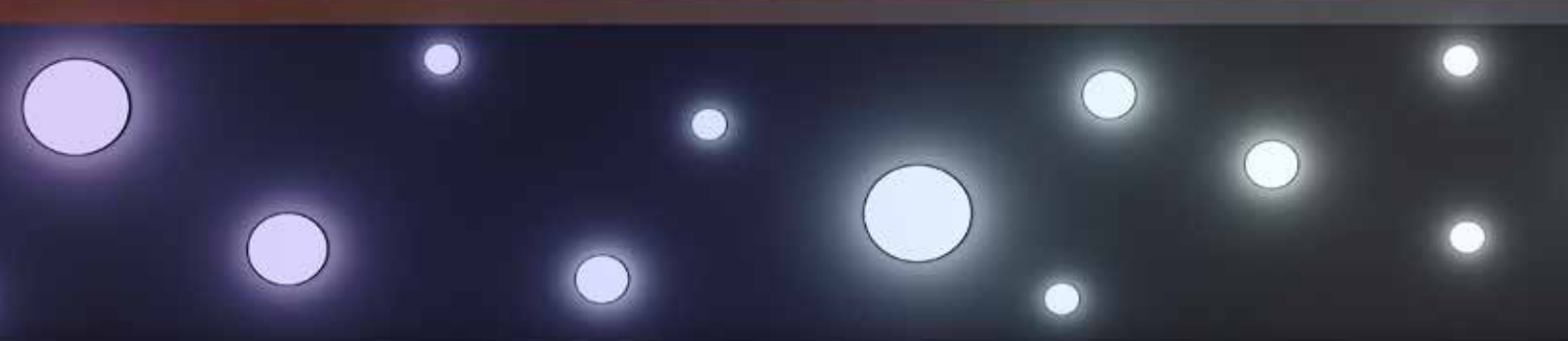

Special accessories:



glare protection



lens 15°



lens 50°



opal disc



honeycomb grid



protection glass IP44

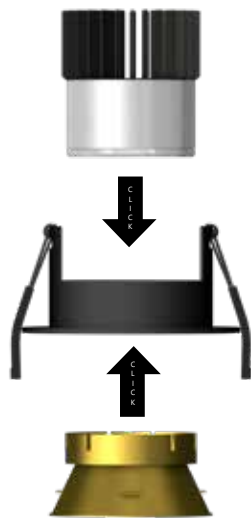

standard version

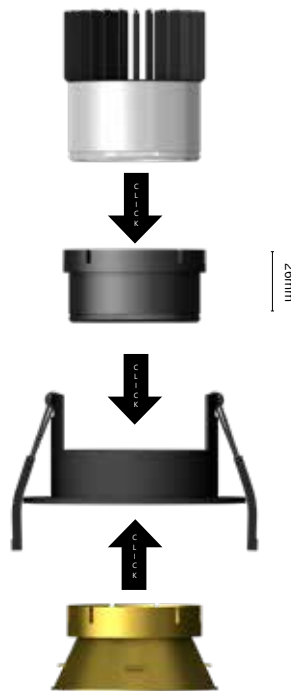

version with moved back anti-glare ring

Anti-glare application

With the new anti-glare ring for Reach LED insert 7W or 13W You reset and glare-free optics.

Attention through the anti-glare ring increases the installation depth of the Recessed spotlight SPOTY by 26mm.